



NPE Buffer System: 4x NPE-32S & 300 Litre Buffer Storage

Product Description

WRAS Approved, Fully Modulating, Continuous Flow Water Heater Modular System for DHW Generation.

The NPE Modular System range is suitable for a variety of DHW generation requirements in commercial applications. Each WRAS approved unit is constructed with stainless steel heat exchanger, and a pre-mix burner for low NOx emissions.

Please see NPE Technical Product Submittal & ProStor NPE DHW Buffer Vessel Technical Product Submittal for further information.

NPE Buffer System Features:

- Modular System
- Easy to Install
- Compact Physical Footprint
- Easy to Service Maintain
- Compact Physical Footprint
- Easy to Service Maintain



Technical Specification: Buffer System: 4x NPE-32S & 300 Litre Storage

Number of NPE-32S Units	4	Fuel Type	Natural Gas or LPG
System Heat Output (kw)	211.2	Gas Inlet Pressure (mbar)	20 Natural Gas 32 LPG
Storage Vessel Capacity (litres)	300	Maximum Operating Pressure (bar)	10
First Hour DHW Output (l/hr) @ 50 Deg C Rise	3933	Minimum Operating Pressure (bar)	1
Second Hour DHW Output (l/hr) @ 50 Deg C Rise	3633		



NPE Buffer System: 4x NPE-32S & 300 Litre Buffer Storage

KEY

- ① ISOLATING VALVE
- ② STRAINER
- ③ PRESSURE REDUCING VALVE
- ④ NON RETURN VALVE
- ⑤ SAFETY RELIEF VALVE
- ⑥ EXPANSION VESSEL
- ⑦ PRIMARY PUMP
- ⑧ DRAIN
- ⑨ SECONDARY RETURN PUMP
- ⑩ TSTAT 1 - CONTROL THERMOSTAT
- ⑪ TEMPERATURE & PRESSURE RELIEF VALVE
- ⑫ TSTAT 2 - MANUAL RESET OVERHEAT THERMOSTAT
- ⑬ DRAIN
- ⑭ NAVIEN NPE TANKLESS WATER HEATER
- ⑮ DHW STORAGE CYLINDER
- ⑯ DRAIN POINT FOR COMMISSIONING WATER HEATER

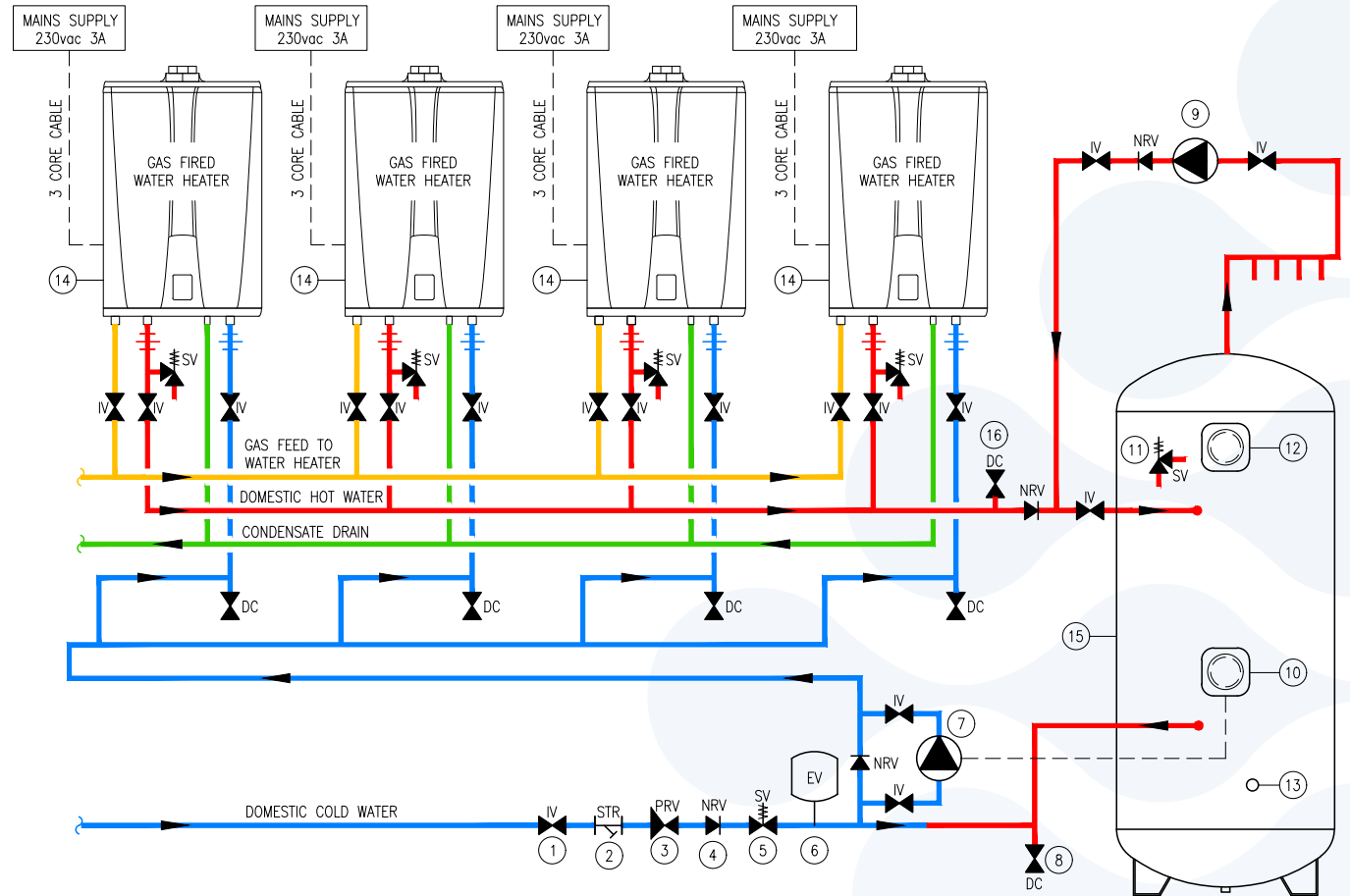

COMMERCIAL HOT WATER SOLUTIONS LTD

The Hive, Weston-super-Mare. BS24 8EE, United Kingdom / 01934 244 770 / sales@chwsitd.co.uk / www.chwsitd.co.uk

